



































GAZELLE S SEAT UNIT







	Configurations	10
	Tutorial video	13
	Preparing the seat unit	14
	Adjusting the seat adapters	17
	Using the DUO stroller	19
	Using the XXL sun canopy	21
	Using the bumper bar	23







	Adjusting the seat position	24
	Adjusting the leg rest	26
	Using the harness system	27
	Folding	31
	Free-standing position	34
	Using the raincover	35
	Removing the fabric	36







	Konfigurationen	10
	Videoanleitung	13
	Vorbereitung der Sitzeinheit	14
	Anpassung der Sitz-Adapter	17
	Verwendung des DUO-Kinderwagens	19
	Verwendung des XXL Sonnenverdecks	21
	Verwendung des Schutzbügels	23

	Einstellung der Sitzposition	24
	Einstellung der Beinstütze	26
	Verwendung des Gurtsystems	27
	Faltung	31
	Selbststehende Position	34
	Verwendung des Regenverdecks	35
	Abnahme des Bezuges	36

	Configurations	10
	Tutoriel vidéo	13
	Préparer le siège	14
	Régler les adaptateurs de siège	17
	Utiliser la poussette DUO	19
	Utilisation du canopy pare-soleil XXL	21
	Utilisation du garde-corps	23

	Réglage de la position du siège	24
	Réglage du repose-pieds	26
	Utilisation du harnais	27
	Pliage	31
	Position debout	34
	Utilisation de l'habillement pluie	35
	Retirer les housses	36

	Configuraciones	10
	Video tutorial	13
	Preparación de la unidad de asiento	14
	Ajuste de los adaptadores del asiento	17
	Uso del cochecito DÚO	19
	Uso de la capota solar XXL	21
	Uso de la barra apoyabrazos	23

	Ajuste de la posición del asiento	24
	Ajuste del reposapiés	26
	Uso del sistema de arneses	27
	Plegado	31
	Posición de pie	34
	Uso de la burbuja de lluvia	35
	Extracción de los tejidos	36

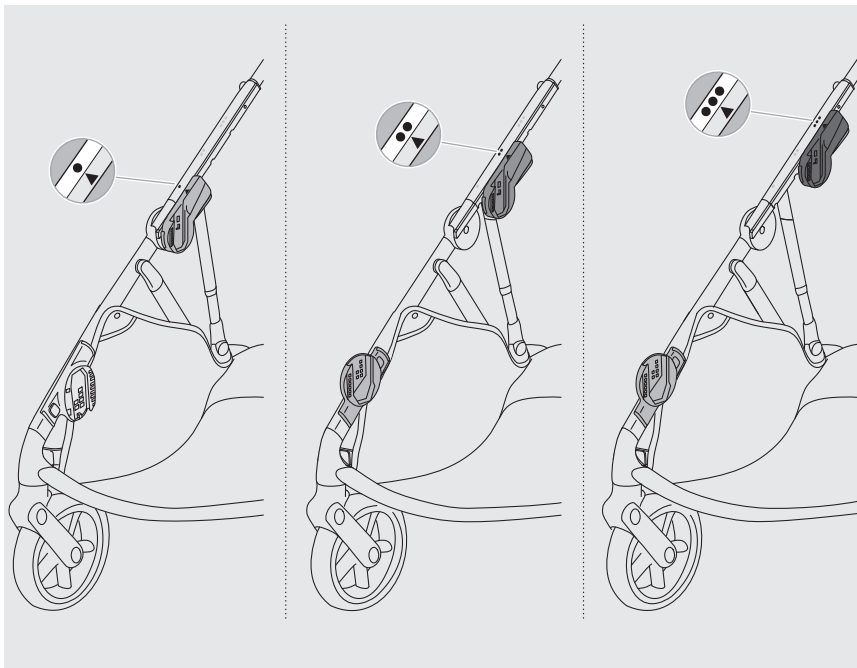



max. 15 kg



max. 22 kg





tutorial video
Videoanleitung
tutoriel vidéo
video tutorial



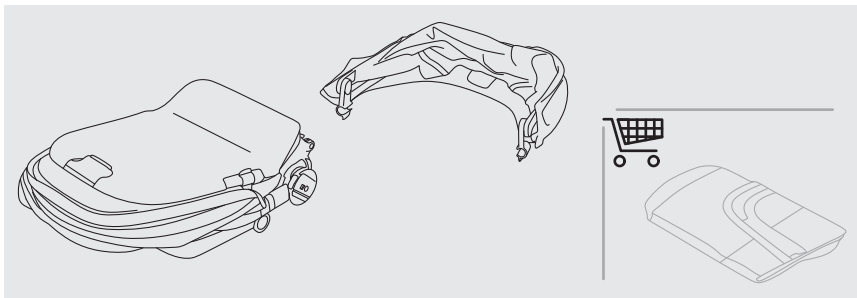

1

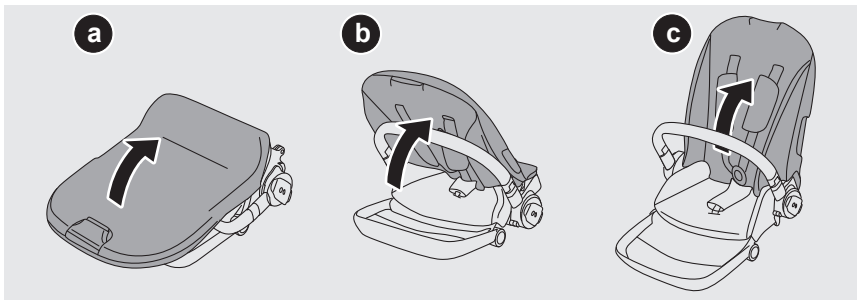

2

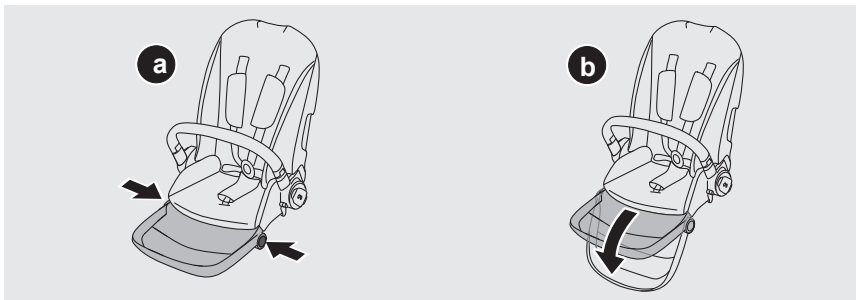

3

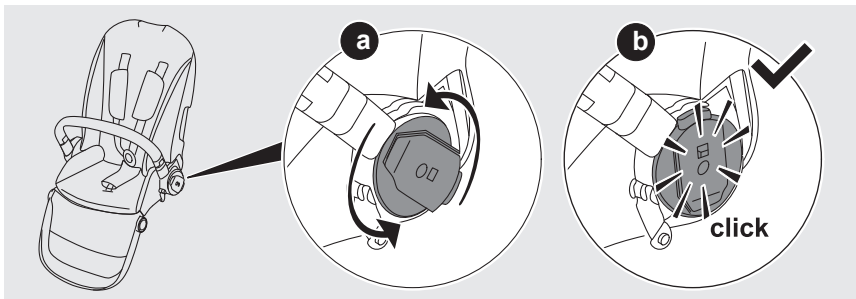

4

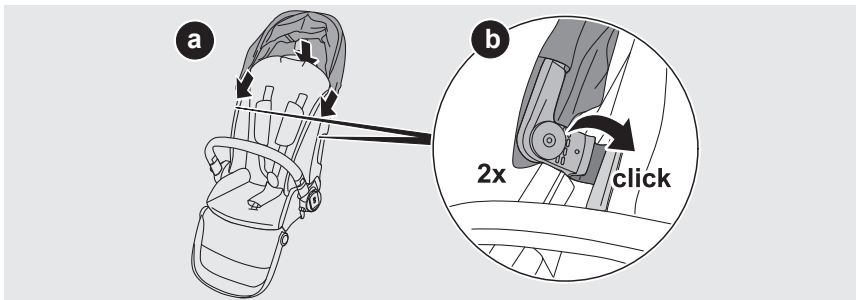

5



6

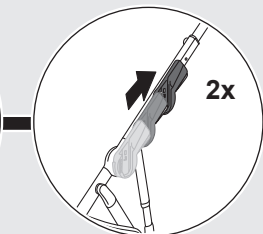
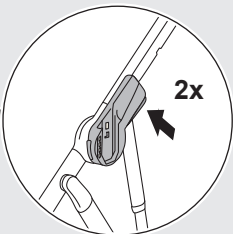

1

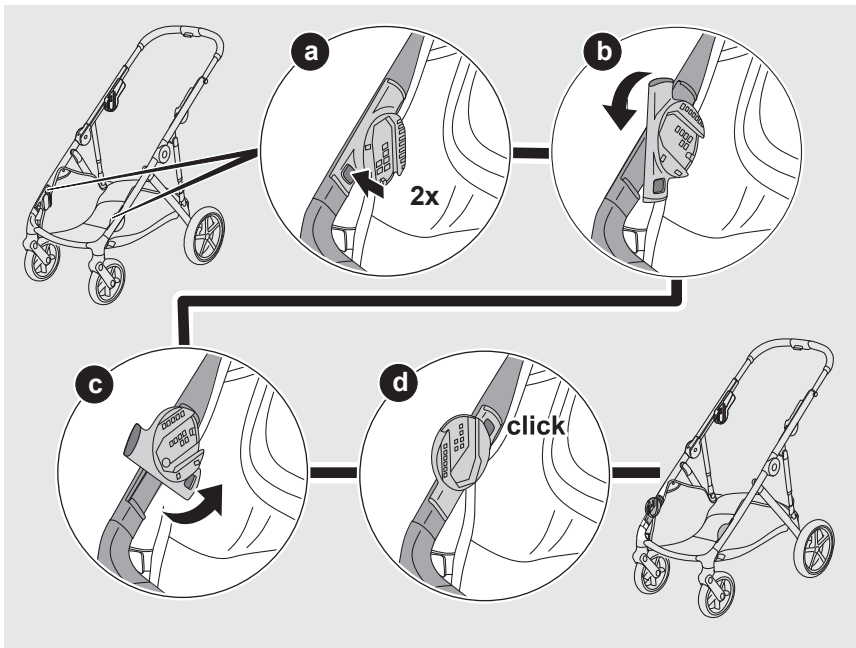

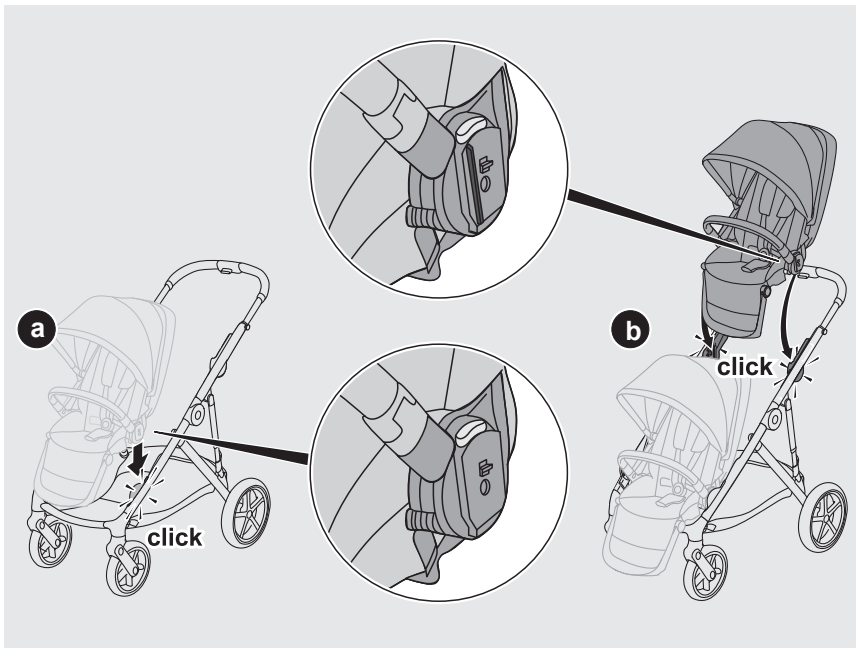

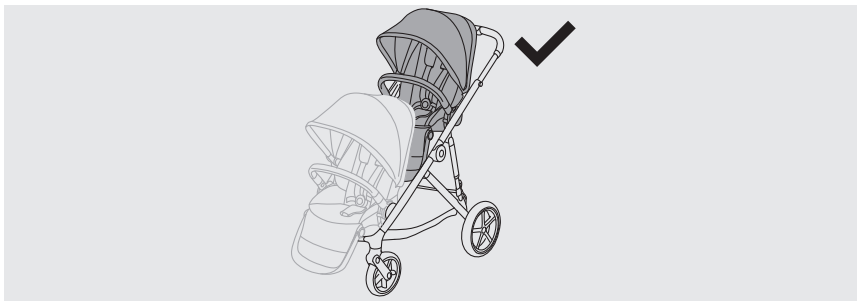

2

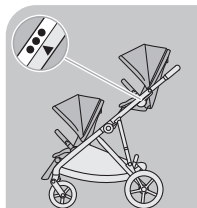
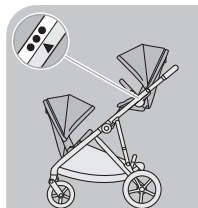
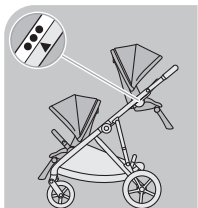
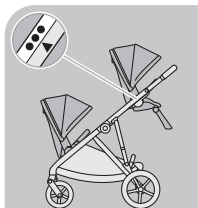

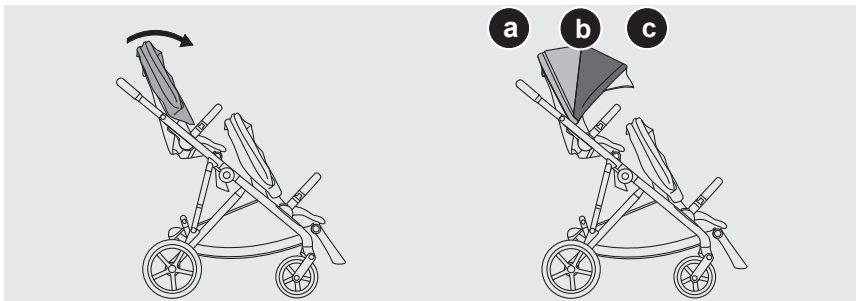

1

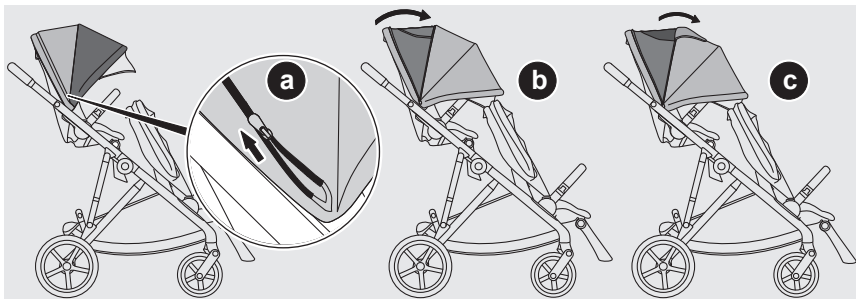

2

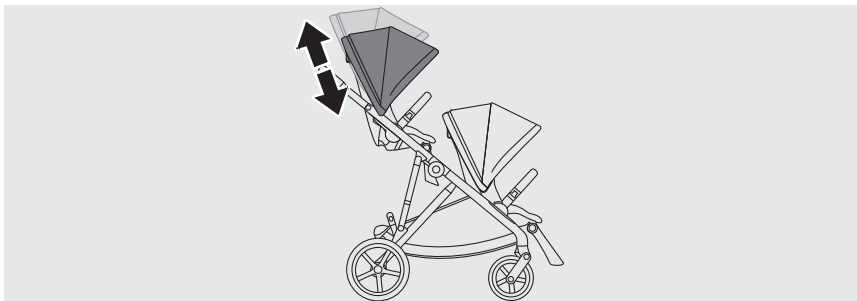

3

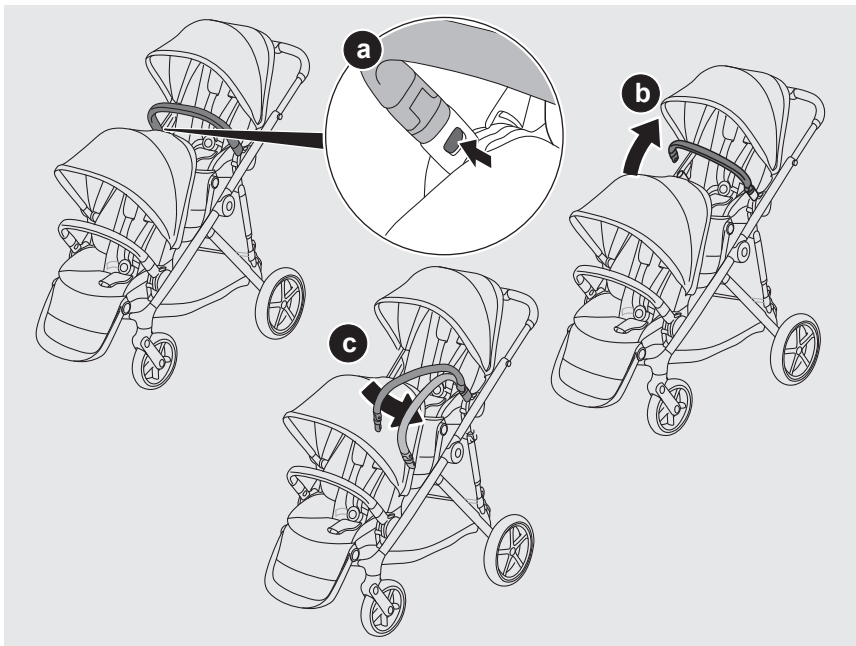

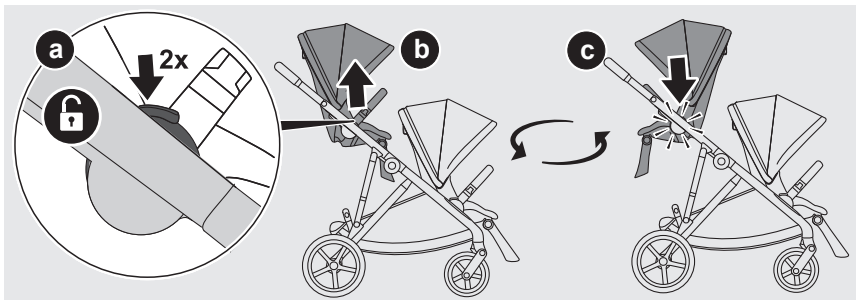

1

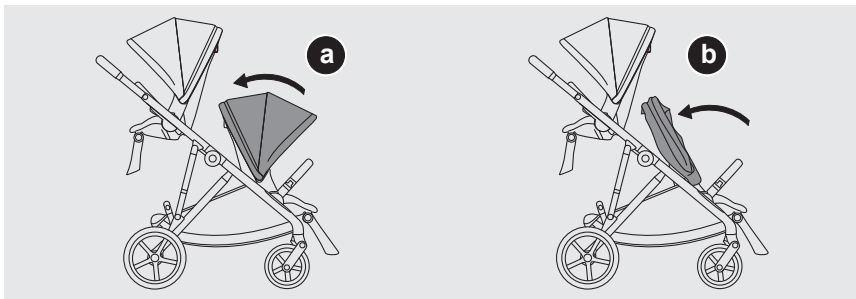

2

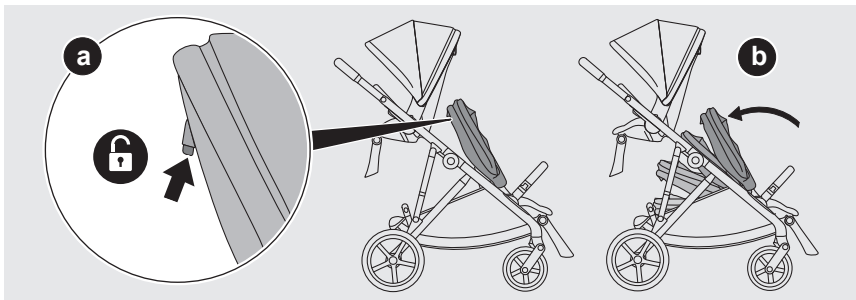

3

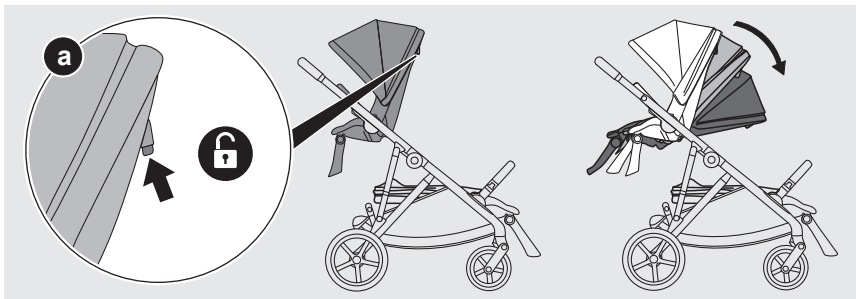

4



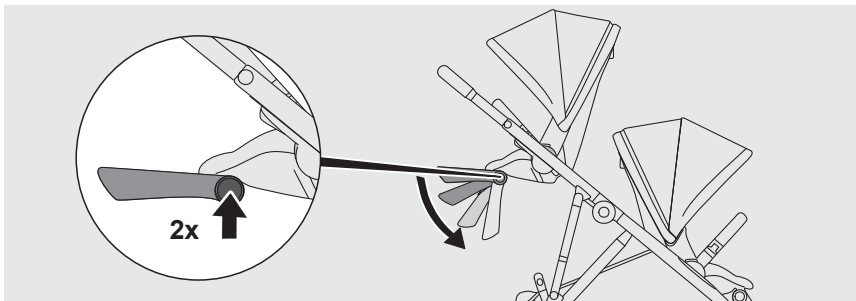

1

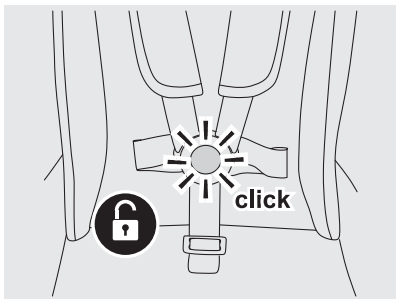

1

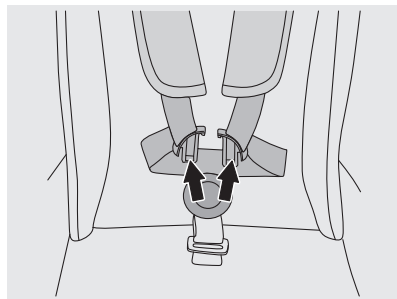

2

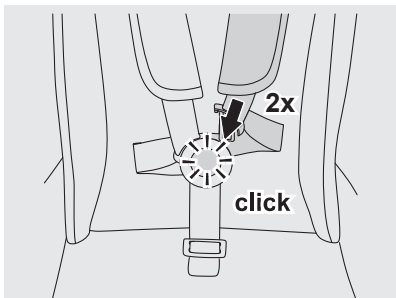

3

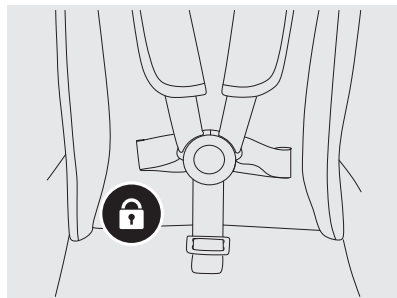

4

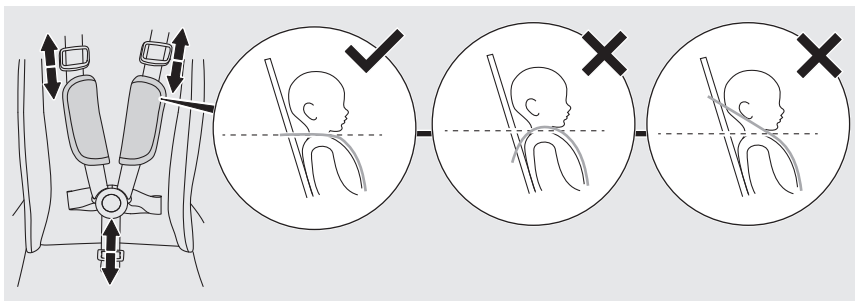

5

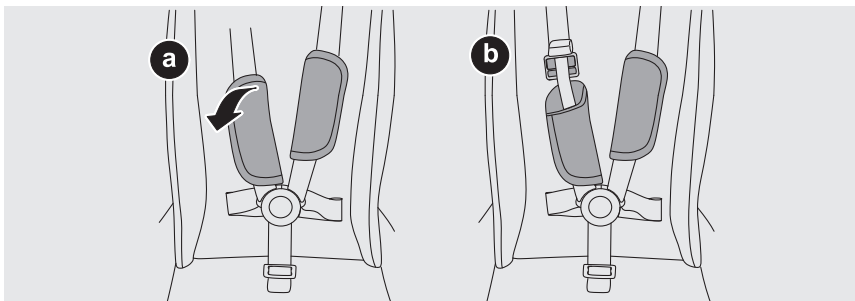

6

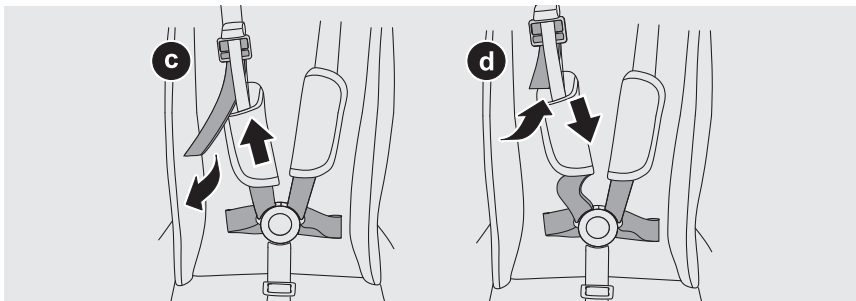

7

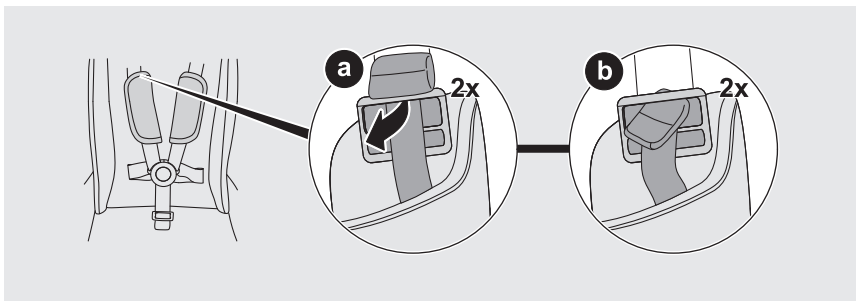

8



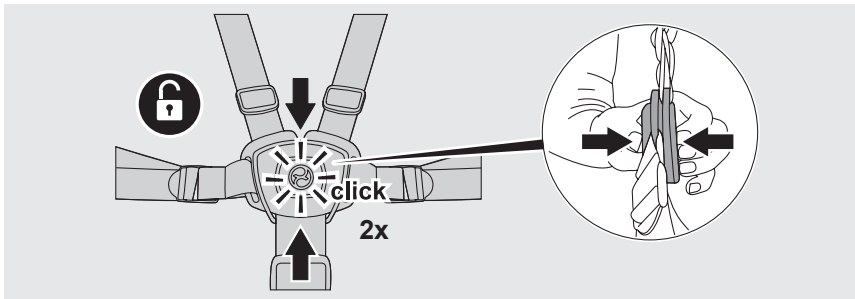

1

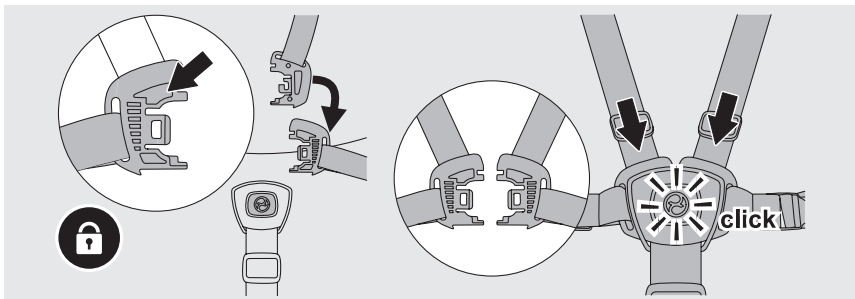

2

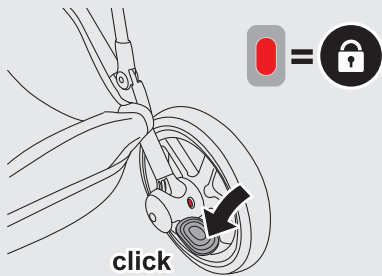

1

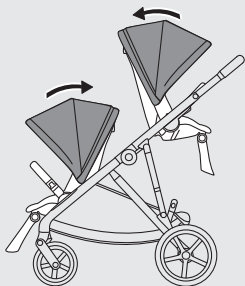

2

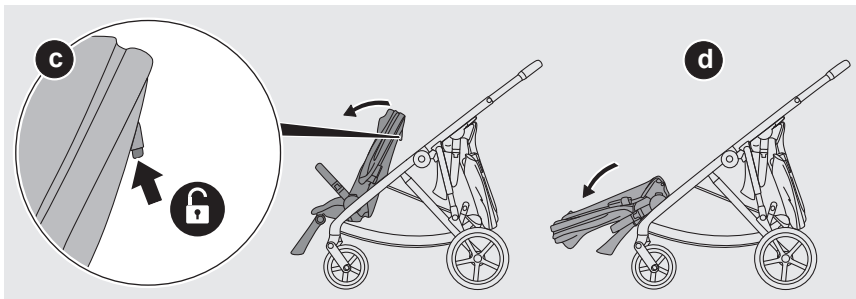
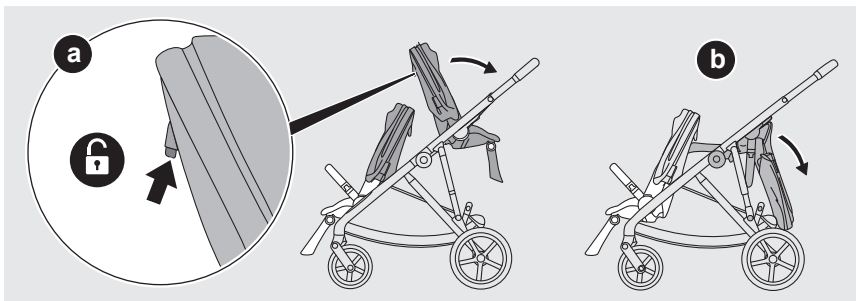

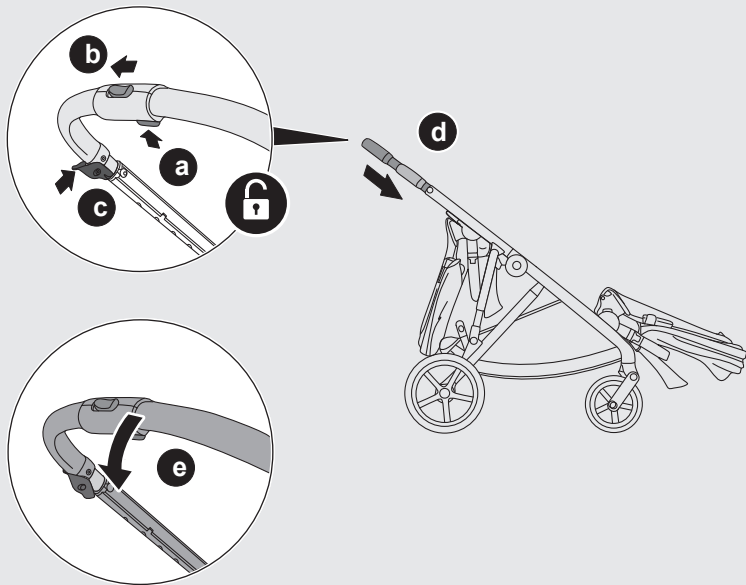

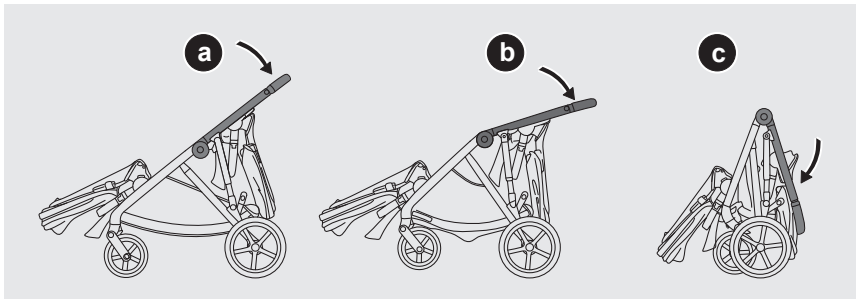

6

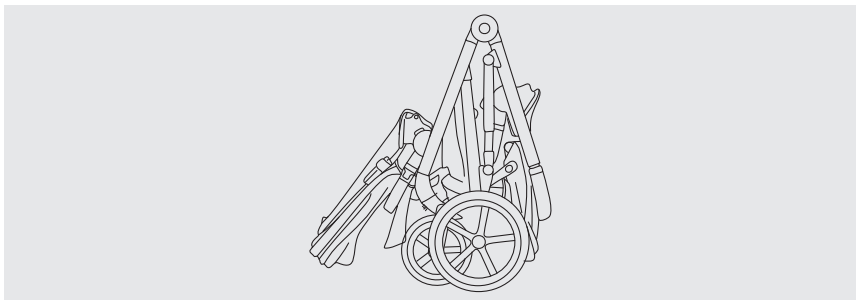

1

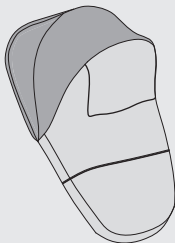

1

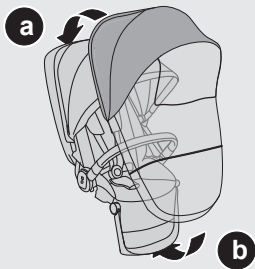

2

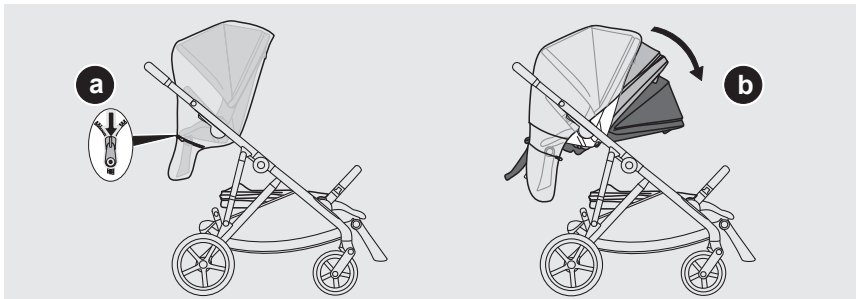

3

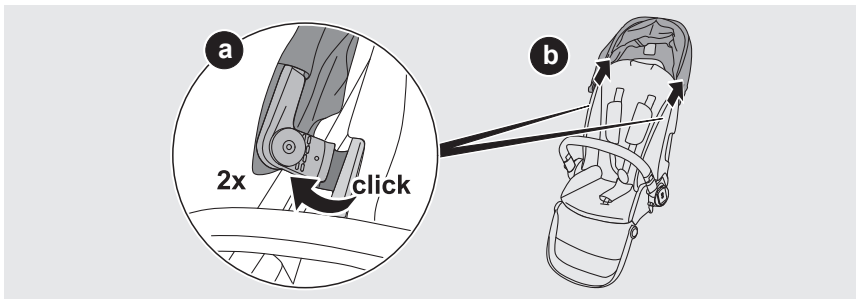

1

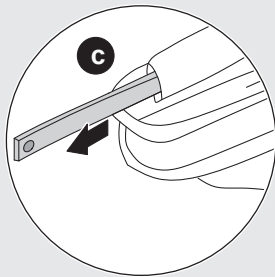
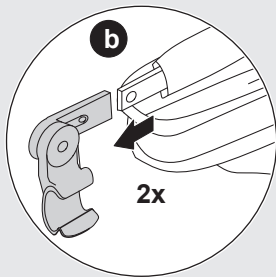
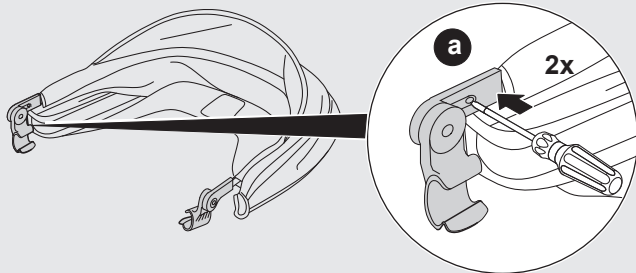

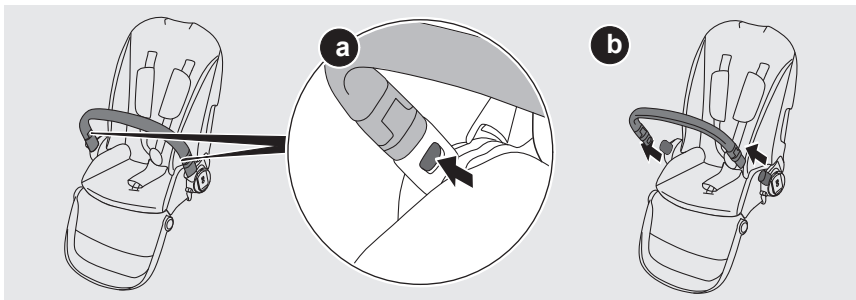

3

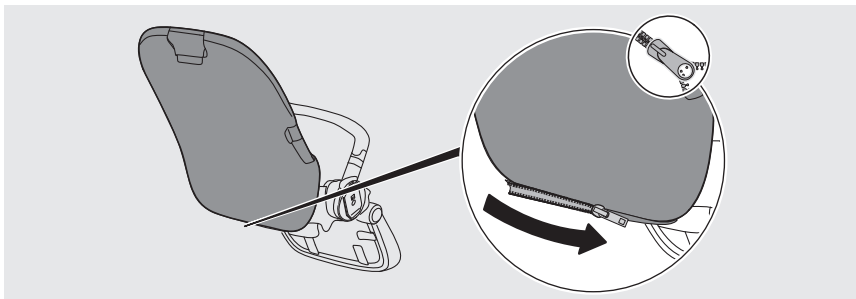

4

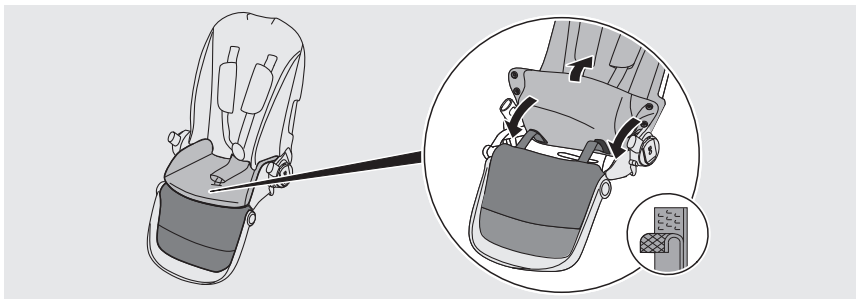
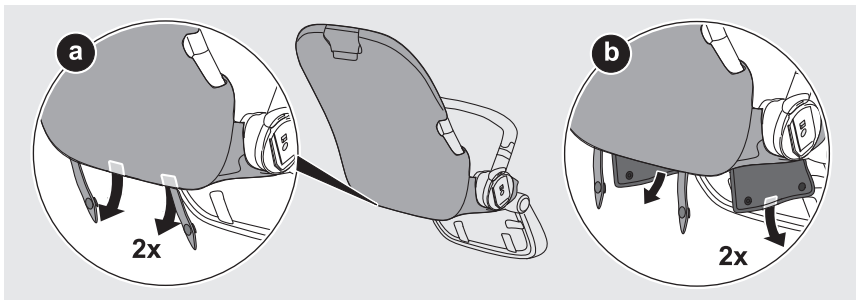

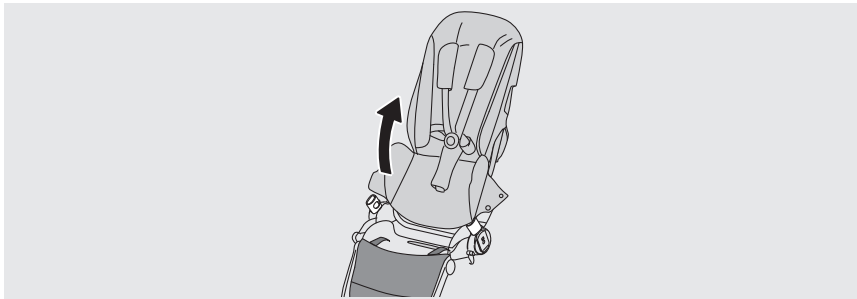

7

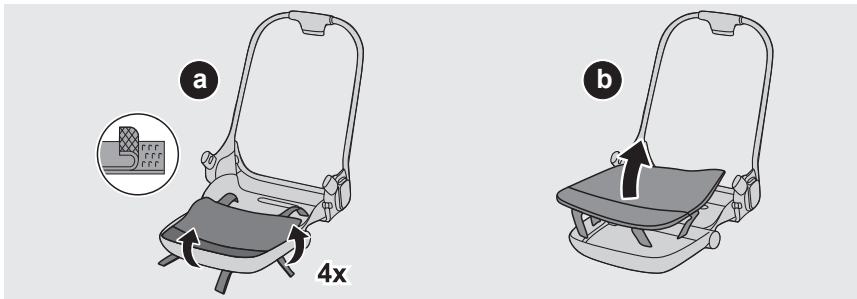

8

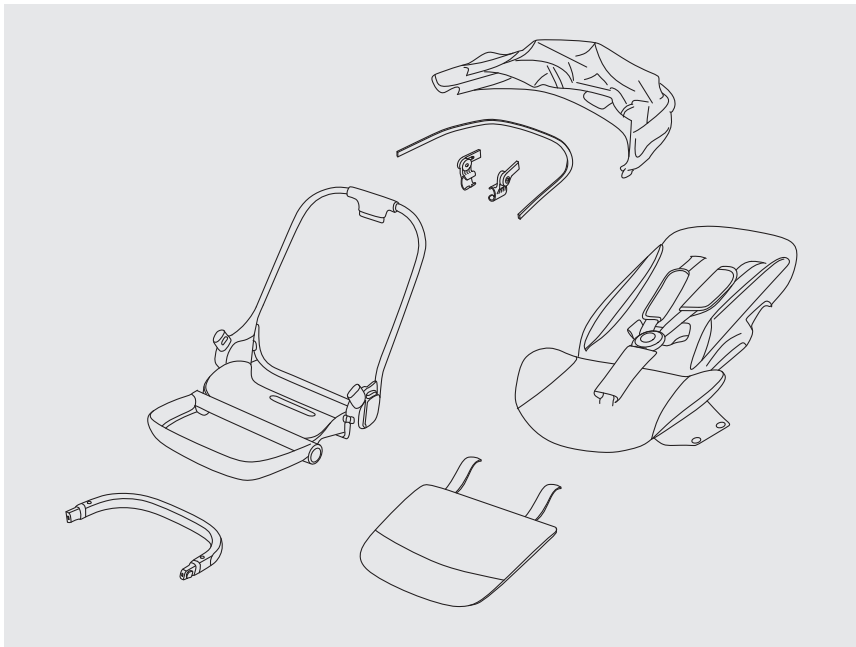



CYBEX GmbH
Riedingerstr. 18 | 95448 Bayreuth | Germany
+49 (0) 921-78 511-0 | info@cybex-online.com
www.cybex-online.com

